

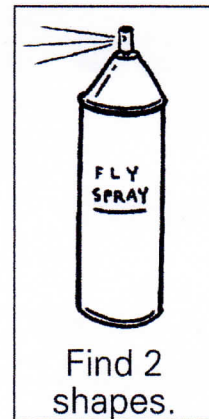

Name

Date

1 Draw lines from the everyday objects to the 3D diagrams.  
Use a different colour for each diagram.

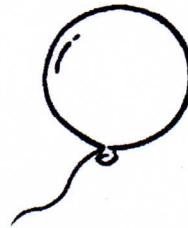
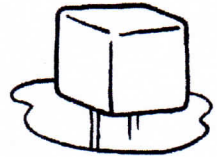
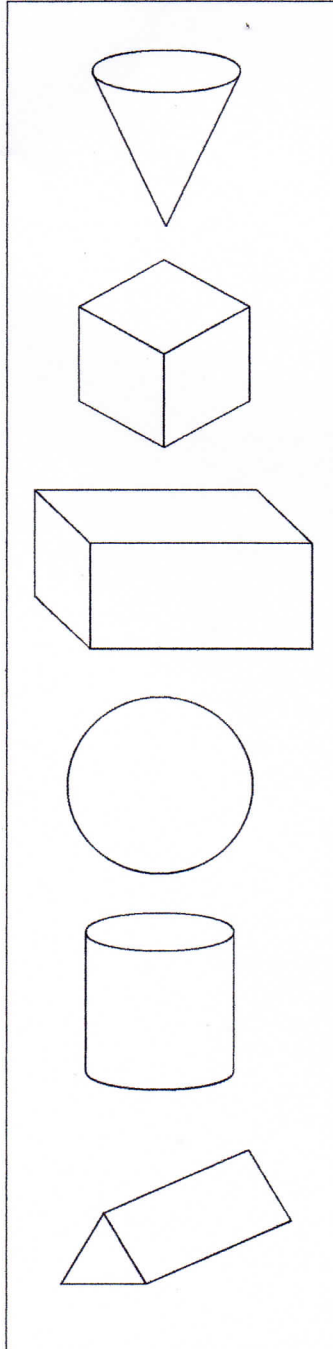
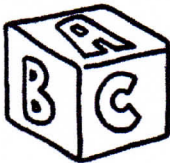
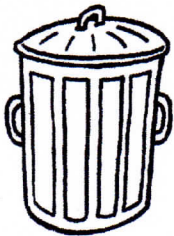
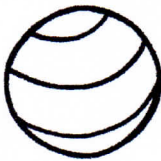
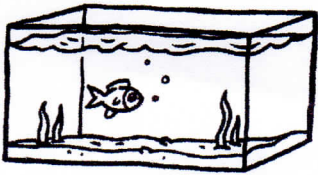

Find 2 shapes.

